

# wedi Fundo Primo

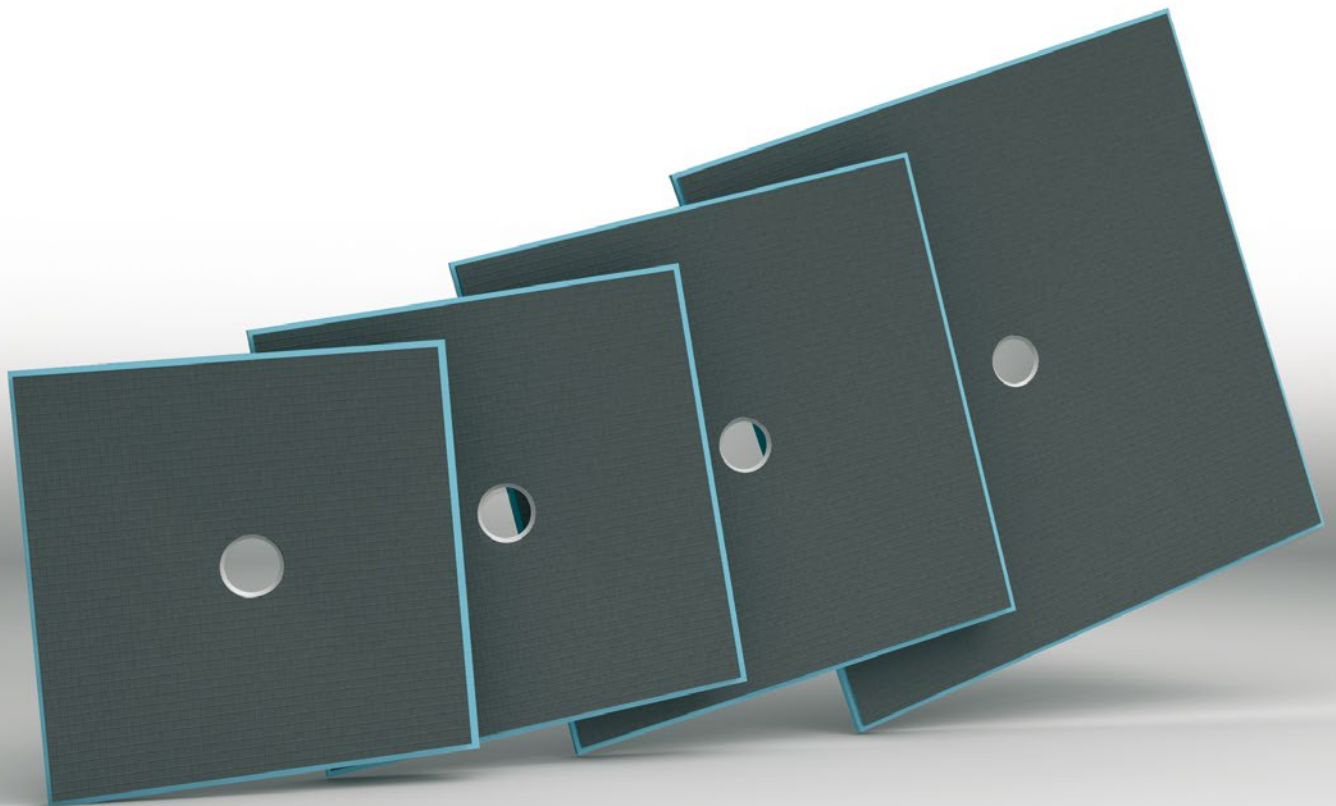

## Overview & General Product Description of the wedi Fundo Shower Systems

All wedi Waterproof Shower Systems including point and linear drain models offer reliable, cost-efficient solutions for constructing 100% waterproof and mold proof showers. The product systems are entirely waterproof due to its XPS extruded polystyrene foam core. These systems are easy and clean to install due to its high prefabrication level. They open up a whole new world of design possibilities for showers, wet areas and baths when customized to fit your jobsite requirements.

wedi Shower Systems blend the traditional values of design flexibility and robustness as previously only enjoyed with screed installations, while offering added values that come with state-of-the-art material and manufacturing technologies. These added values come in form of many performance advantages. Especially over traditional screed installations or over other currently known methods for building showers such as those using sheet – or liquid waterproofing membranes in an attempt to manage water exposure. The most unique advantage is the complete and natural core waterproofness of the wedi product and its entire assembly. Every detail of the assembly is part of the wedi waterproofing approach: even down to the factory integrated drain parts. The concept of the wedi Fundo Shower System's water management describes a true "water out" performance. Neither products nor the assembly of the wedi Fundo shower system is subjected to the risks so commonly found in other methods of shower installation. When installing wedi Fundo Shower Systems in combination with wedi building panels, the proprietary wedi 610 adhesive sealant and any of our curbs, niches or seats accessories, you can eliminate the following worries altogether:

- No overlapping sheet waterproofing seams with just thinset in between
- No risk of forming pinholes as with installation of very thin liquid membranes
- No weepholes and clogging as with liner installations
- No liner cracks due to aging or exposure to elements
- No risky liner seams in larger size showers nor any risky corner liner tapes
- No mold or discoloration worries as with absorbing and permanently wet screed beds

These added values and its detail perfections eliminate the technical concerns in shower installations. But this is not where wedi shower systems stop offering its added values: The wedi Fundo shower system adds to your productivity and enables you to provide real value to your customers: Our wedi Fundo Shower systems reduce the installation time for just the shower floor from a 2–3 day process (includes drying times) to only 30 minutes when compared to traditional methods built with screed and liquid applied membranes. wedi helps you to turn showers into service quicker, cleaner, safer. The exact and consistently shaped slope fields support perfection in tile setting and design. The cement based resin surface coatings on our products provide a great bond surface for any tile, stone and many other materials. Using any cement based thinset adhesives in installation. The insulation properties of the extruded foam core of our wedi systems keep the tile warmer on the floor and add to better insulation of the wall. And all this under one warranty for the entire shower from floor to wall.

wedi Fundo Ligno is designed to provide for a low profile base thickness of only 19 mm. This allows for a fast and flush installation into a subfloor assembly without cutting into floor joists. The system is designed to work without a curb. Enjoy the ease of installation without creating a structural hazard because you maintain the structural subfloor panels installed between floor joists under the wedi Fundo Ligno. Because barrier free showers may be exposed to heavy point loads (e.g. wheel chair), you can confidently rely on the structural strength of the wedi base and subfloor as well as the wedi Fundo's traditional strong cement based surface for ideal tile bond using any suitable cement based tile adhesives or grouts. As always with wedi Fundo Shower Systems, wedi Fundo Ligno is designed to interlock and work with wedi Building panels, wedi 610 adhesive sealant, wedi Fasteners, wedi Seats and Benches, wedi Niches and many more accessories, that truly complete your shower installation and waterproofing system. The installation is fast, modular but customizable, and covered by wedi's full system warranty.

## Drain to Base Assembly

These added values and its detail perfections eliminate the technical concerns in shower installations. But this is not where wedi shower systems stop offering its added values: The wedi Fundo shower system adds to your productivity and enables you to provide real value to your customers: Our wedi Fundo Shower systems reduce the installation time for just the shower floor from a 2 day process (includes drying times) to only 30 minutes when compared to traditional methods built with mortar mix and topically applied liquid membrane. wedi helps you to turn showers into service quicker, cleaner, safer. Especially for our contractors, Fundo Primo helps to get to setting tile faster and on a much more consistent and tile friendly surface. Customers will appreciate the 'no noise and no dirt and dust' installation. The wedi products do not contain harmful ingredients providing peace of mind to contractors and end users.

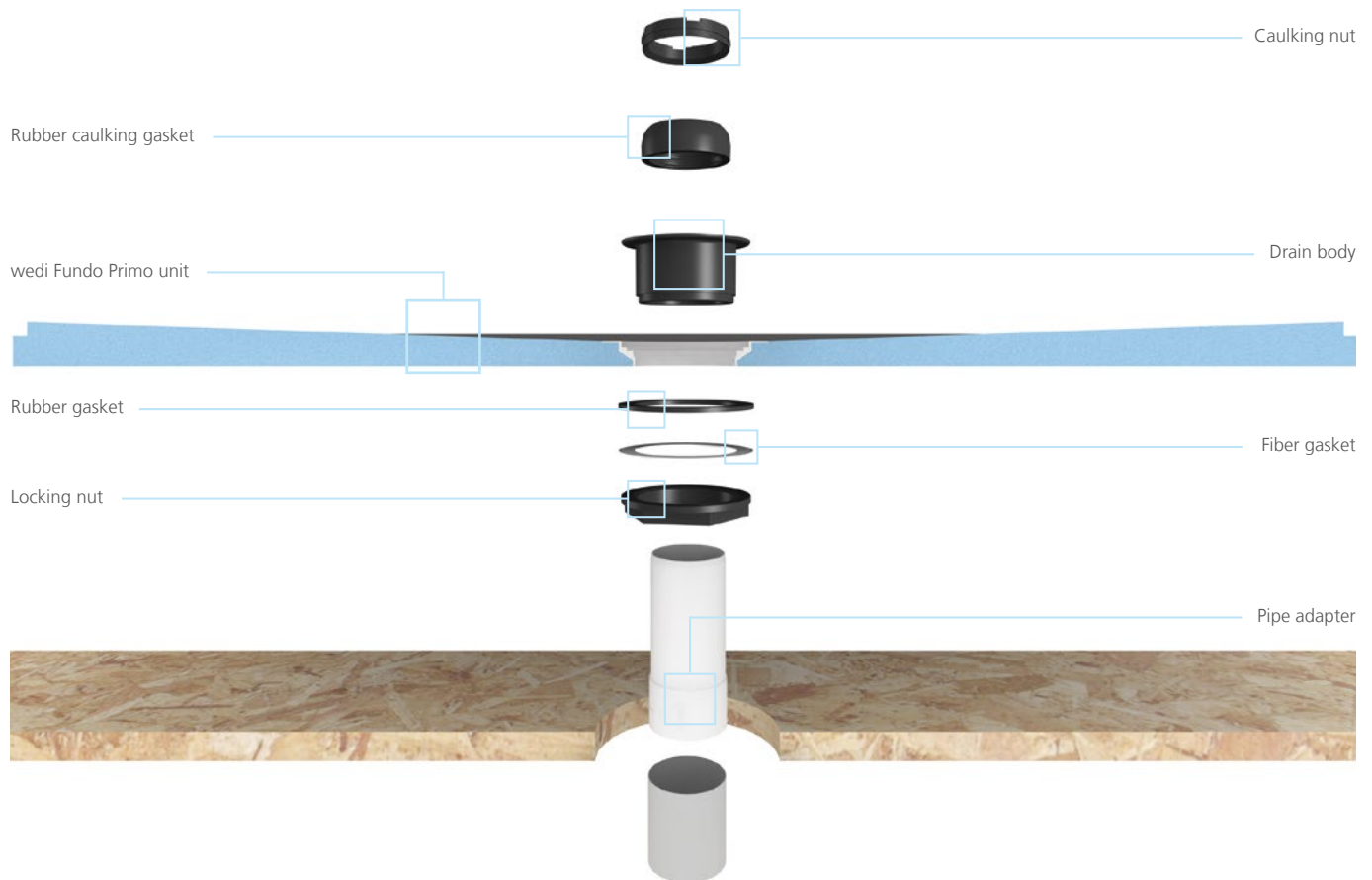

**!** Several Fundo Primo models naturally feature different perimeter height or thickness at the edge. Therefore, pre-made standard notch connections of wedi hobs must be modified in the field for a tight fit to the bases. Ramps and Extension boards can naturally not fit to all models and might be modified in the field as well.



## wedi Fundo Primo Installation

### Before Installation:

- Subfloor and wall framing construction meets applicable building code and is sufficiently loadbearing, even and free of contaminants.
- Cut the DN 50 floor waste pipe using an inside pipe cutter at least 40 mm below the top of your substrate.
- Make sure you use a PVC Primer and Glue for the Drain Adapter.
- Only wedi products (Building Boards, Hob, wedi 610 adhesive sealant and fasteners) are used for wedi Fundo Shower System assembly.
- Installer has received instructions from wedi technical sales staff or is informed about proper installation methods as described.
- wedi shower bases can be cut to size using a skilsaw. The Z notch channel must be remade and cleaned from sawdust or contaminants.



Cut the DN 50 floor waste pipe at least 40 mm below the top of the floor surface. Make sure that the cut out fits to the Fundo board drain. Cut out a 130 mm diameter hole around the DN 50 pipe to allow the wedi drain to be inserted into the subfloor while the cut out area must remain free of deflection. Glue the Adapter to the DN50 Pipe so that the Adapter is sticking out of the subfloor.



Cut the Adapter flush to the floor construction. Make sure that the cut out fits to the Fundo board drain.



Assemble the drain unit following the instruction drawing.

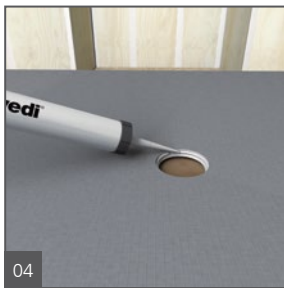

Set up a continuous 5 mm bead of wedi 610 adhesive sealant along the channel in wedi Fundo's drain flange receptor.



Drop the drain body firmly into the sealant.

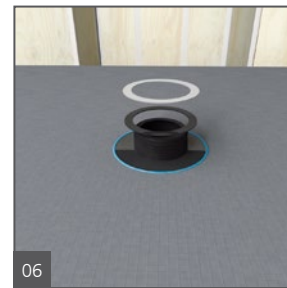

Turn the Fundo base upside down and apply the rubber and the fiber gasket. Tighten the gaskets firmly to the bases' steel ring using the locking nut. Make sure the drain body is still safely received in the valve-bead of sealant.



Tighten the gaskets firmly to the bases' steel ring using the locking nut. Make sure the drain body is still safely received in the valve-bead of sealant. Smooth out excess sealant over the drain body's flange surface.

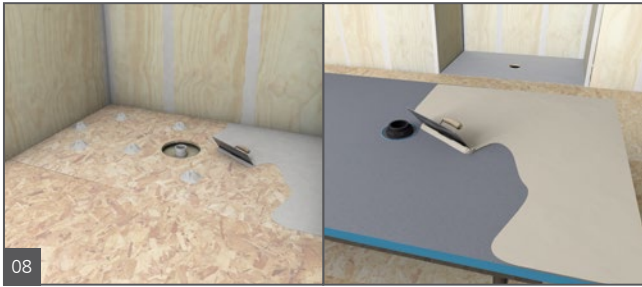

Trowel the tile adhesive and comb through with a 10 × 10 mm notch trowel. Channels pointing to the entrance.

Trowel the tile adhesive on the rear side of the Fundo again using a 10 × 10 mm notch trowel. There are different ways to ensure good bond of the wedi base to the subfloor. Applying tile adhesive on both, wedi base and subfloor, is a best practice recommended to achieve full surface coverage adhesion.

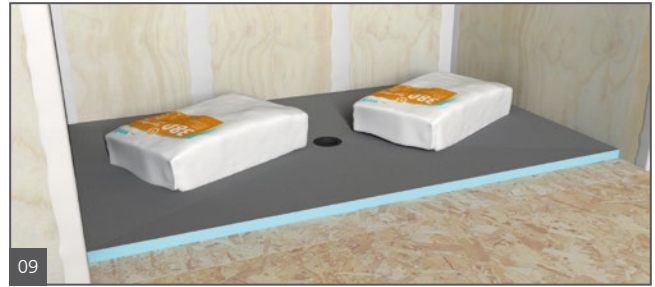

Press the Fundo firmly into the thinset bed, ensuring that the installation is level and void free.

Apply some weight equally and leave on surface and drain area to allow the thinset to initially cure without being disturbed (e.g. thinset bags). Do NOT step on the drain module to push/connect to drain body or thinset. Ensure there is 100 % thinset supporting the drain channel area over a completely flat subfloor.

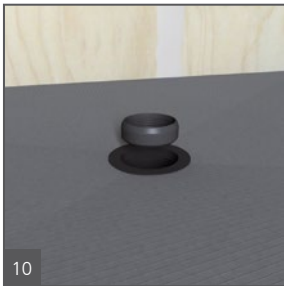

Set up the rubber caulking gasket (with the bevelled side up) around the 50 mm pipe in the subfloor. The rubber gasket must be flush with the upper end of the 50 mm ABS or PVC pipe.

**Do Not use any Lubricants.**

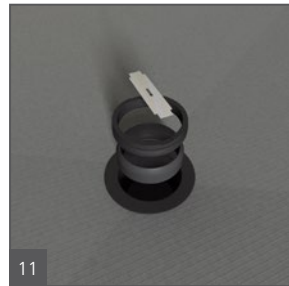

Tighten (squeeze) the rubber caulking gasket firmly with the caulking nut (use a flat headed screwdriver) and finally insert the plastic frame and strainer on top (without adhesive). The frame and strainer will be held in a grout joint only once tiling commences.

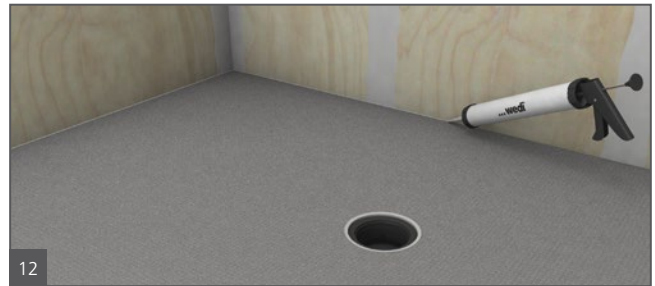

Set up a continuous 10 mm bead of wedi 610 adhesive sealant along the pans channel on the outer perimeter and only in areas where you can immediately install a building board into the fresh sealant.



Push the wedi board all the way into the channel of the shower base channel and its bead of sealant. Smooth out any pushed out sealant on inside seam using a putty knife. Fasten the boards directly to the studs starting 300 mm above the base and at a rate of 1 fastener per 300 mm. One extra fastener is set into the seam to the next board to create a flush transition.



Apply continuous 10 mm beads of sealant between all connections of boards and install with tightly butted seams. Excess sealant must be spread flat with a putty knife. All seams and fastener heads in the assembly are covered with a secondary 10 mm bead of sealant and spread flat. The seams should be covered 25 mm on either side of seam. All fastener/washers are covered with sealant stretching 25 mm over the washer edges.

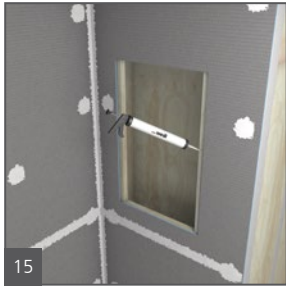

wedi Niches are installed in a cut out in the wedi wall and attached with it's flange right into the center of 450 mm studs. wedi 610 adhesive sealant is set along the connection of wall to niche.

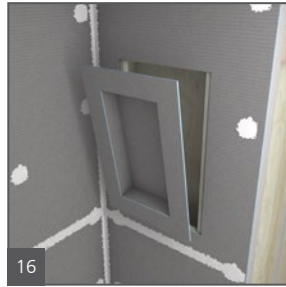

2 Fasteners each side of the niche are set to create a flush transition to the wall boards. Another 10 mm bead of wedi 610 adhesive sealant is spread over fasteners and seams.



A continuous 10 mm bead of sealant is set into the channel and along the vertical hob notch part. A circle of 10 mm sealant bead is set against the wall boards where the hob attaches. A 10 x 10 mm notch trowel bed of cementitious tile adhesive is applied to the subfloor and a skim coat on the bottom surface of the hob as a best practice. The tightly fitting hob is pressed into the connection area.

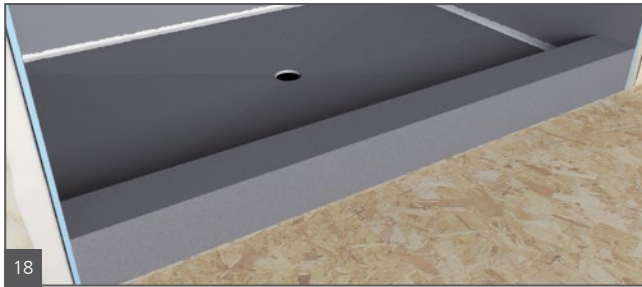

Weight is applied on and against the hob (from outside) and another 10 mm bead of sealant is applied over all hob seams and spread flat. The seams must be covered 25 mm either side of a seam.

**!** Hob connection notches must be cut to fit select Primo bases with perimeter thickness higher than 38 mm. For a fully waterproofed installation please install wedi sealing gaskets for mixing valve and shower head cut outs.

## wedi Drain Cover Assembly / Insertion

Insert Cover frame into base hole (no glue/no screws). You may caulk between part and tile to create a flexible grout joint. The optional Extension Collar can be cut to height if part is needed. The caulk joint must not create a water barrier damming up the water draining through the thinset bed into the drain from below the tile. Therefore the thinset layer must be continuous toward the drain.

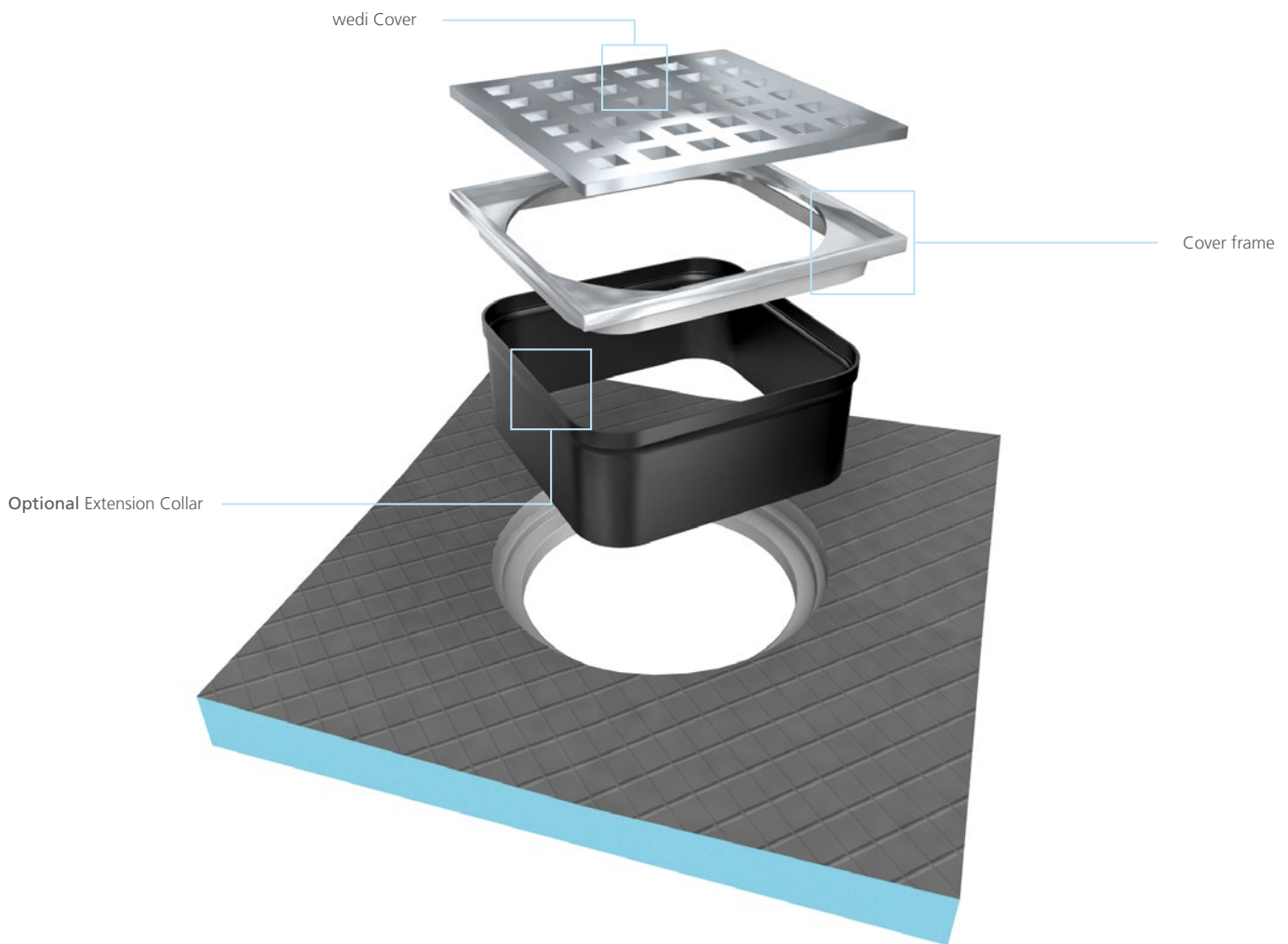



Fundo Standard  
Stainless Steel Cover/Frame



Fundo Fino Tile insert Cover Plate,  
for tiles with a maximum thickness of 13 mm

**i** Please note: A Drain cover has to be purchased separately and can be found in various different designs at [www.wedi.com.au](http://www.wedi.com.au)

## wedi Fundo Primo | Square and Rectangular Shower Bases, Center Drain

	Description	Dimensions	Unit	Item #
	wedi Fundo Primo, square	1020 × 1020 mm	1 pc	073736220
	wedi Fundo Primo, square	1220 × 1220 mm	1 pc	073736222
	wedi Fundo Primo, square	1524 × 1524 mm	1 pc	073735518
	wedi Fundo Primo, square	1830 × 1830 mm	1 pc	073735524
	wedi Fundo Primo, rectangular	914 × 1524 mm	1 pc	073735506
	wedi Fundo Primo, rectangular	1220 × 1020 mm	1 pc	073736221
	wedi Fundo Primo, rectangular	1220 × 1524 mm	1 pc	073735509
	wedi Fundo Primo, rectangular	1220 × 1830 mm	1 pc	073735508
	wedi Fundo Primo, rectangular	1220 × 2134 mm	1 pc	073735522
	wedi Fundo Primo, rectangular	1524 × 1830 mm	1 pc	073735519
	wedi Fundo Primo, rectangular	1524 × 2134 mm	1 pc	073735523

**!** When working with modular wedi hobs or ramps the connection notch might need to be adjusted in the field.  
Please do not forget to purchase separately the Drain Assembly Kit and the Drain Cover.

Bases are adjustable to nominal sizes in the field.

**i** All Fundo dimensions are outside-dimensions including the Z-Notch. Please refer to the technical drawings on the wedi website [www.wedi.com.au](http://www.wedi.com.au)

## wedi Fundo Primo | Rectangular Shower Base, Offset Drain

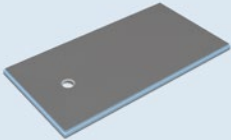
	Description	Dimensions	Unit	Item #
	wedi Fundo Primo, rectangular	1820 × 920 mm	1 pc	073736230

**!** For tub replacement installations.  
Bases are adjustable to nominal sizes in the field.



## wedi Fundo Primo and Ligno Drain Kit



Description	Unit	Item #
wedi Fundo Primo and Ligno Drain Kit	1 pc	US1000040

## wedi Fundo Standard | Drain Cover, Stainless Steel Base

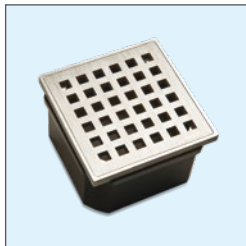

Description	Width × Length	Unit	Item #
wedi Fundo Drain Cover Set, Brushed Stainless Steel	100 × 100 mm	1 pc	US1000031

- ! For this drain cover, the height of your tiling must be at least 6 mm.
  - For use with wedi Fundo Primo, Ligno, Trollo, Nautilo bases.
- w 1 drain cover, stainless steel
  - 1 frame

## wedi Fundo Fino | Tileable Cover Plate, Stainless Steel Brushed

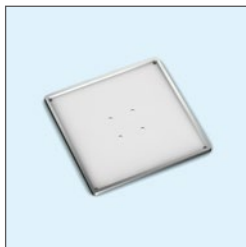

Description	Unit	Item #
wedi Fundo Fino Tileable Cover Plate, square	1 pc	US5000087

- ! For use with wedi Fundo Primo, Ligno, Trollo, Nautilo bases.
  - Tileable cover plate surface is elevated 2 mm over tile surface of a Fundo base. For a flush tile installation, wedi 610 adhesive sealant spot bonding may be used to install the tile inside the cover so height is reduced versus the thinset bed build up under the tile on the shower base.
- w 1 drain cover, stainless steel
  - 1 Frame, stainless steel



## Did you know?

Great Quality Installation results depend on not only having great products to use – the Know-How and Experience in how to use them is key too. wedi trained and certified all Baeumler Quality Construction installers in my team and now they fully know and appreciate what they can achieve with wedi.

This educational service is offered to all professional contractors of all trades and wedi's local Technical Sales Support Managers come out on site and install with you when you do your first wedi shower installation. Your peace of mind – at no charge. Just a call away!



wedi Australia & New Zealand

Phone: +61 437 678 459

info@wedi.com.au  
www.wedi.com.au



Be sure to ask for:  
Certified wedi Installer.

Your local wedi distributor:

