

# Fundo Top<sup>®</sup>

für Fundo Riolito/Riolito Neo | for Fundo Riolito/Riolito Neo  
pour Fundo Riolito/Riolito Neo

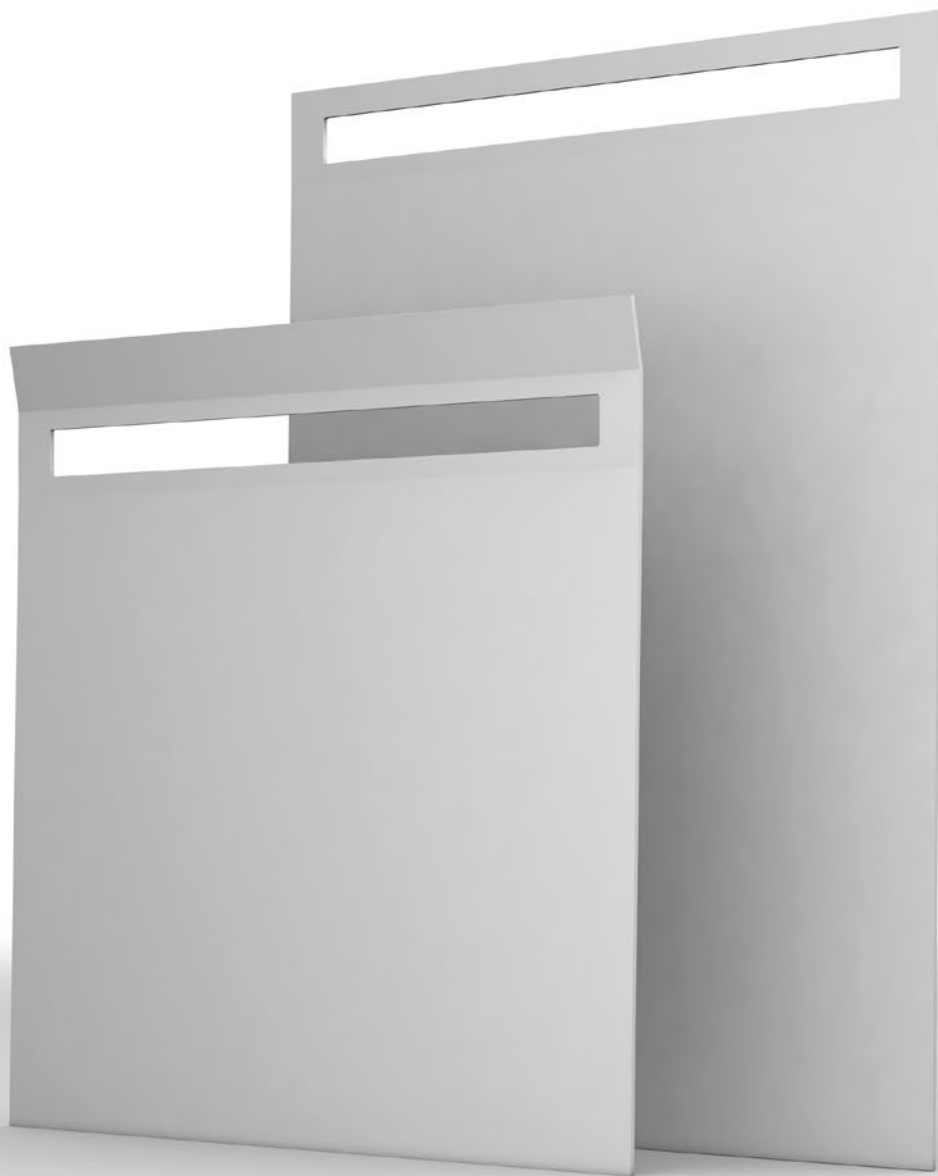

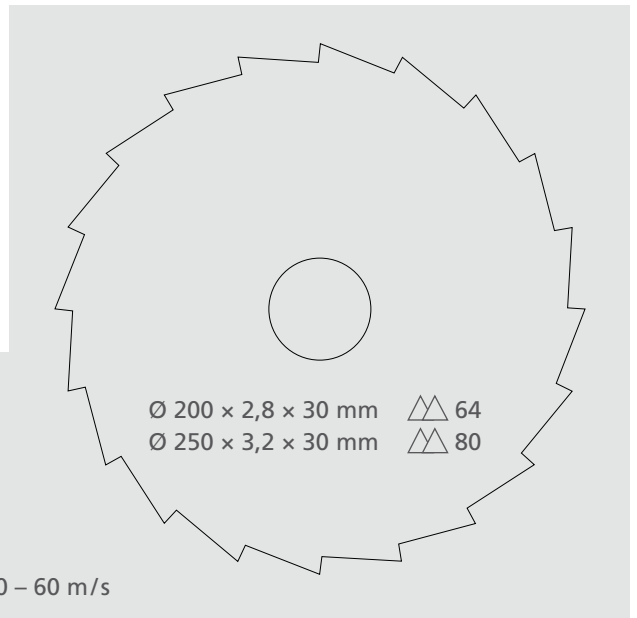
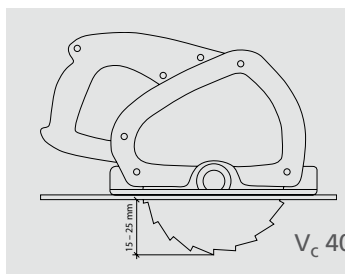
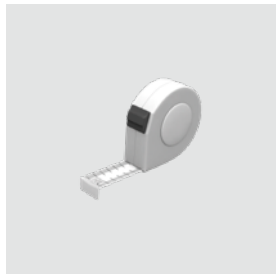
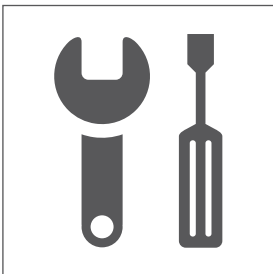
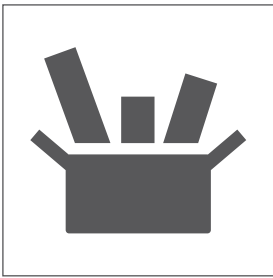

wedi 610

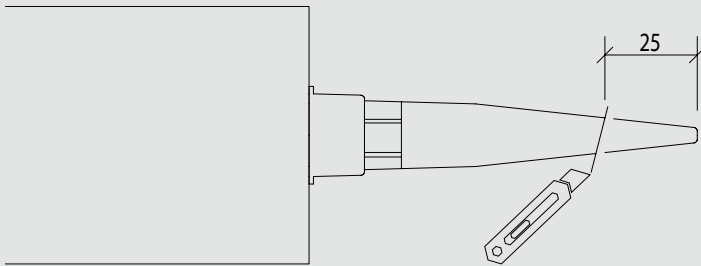

Fundo Riolito

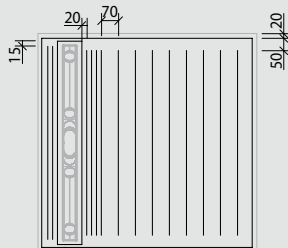

Fundo Riolito  
**900 × 900 mm**  
2 × wedi 610

Fundo Riolito Neo

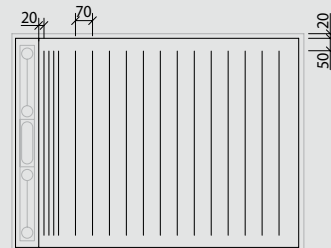

Fundo Riolito Neo  
**1.200 × 900 mm**  
2,2 × wedi 610

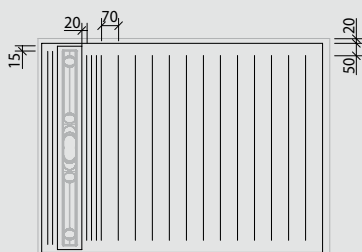

Fundo Riolito  
**1.200 × 900 mm**  
2,4 × wedi 610

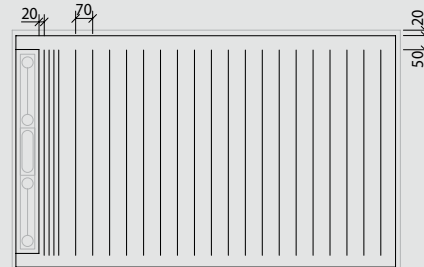

Fundo Riolito Neo  
**1.600 × 1.000 mm**  
3,2 × wedi 610

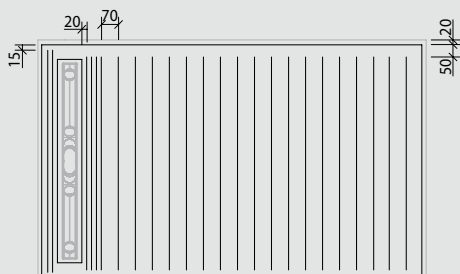

Fundo Riolito  
**1.600 × 1.000 mm**  
3,4 × wedi 610

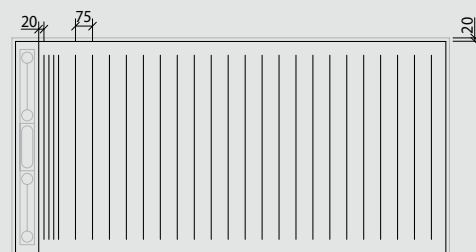

Fundo Riolito Neo  
**1.800 × 900 mm**  
3,1 × wedi 610

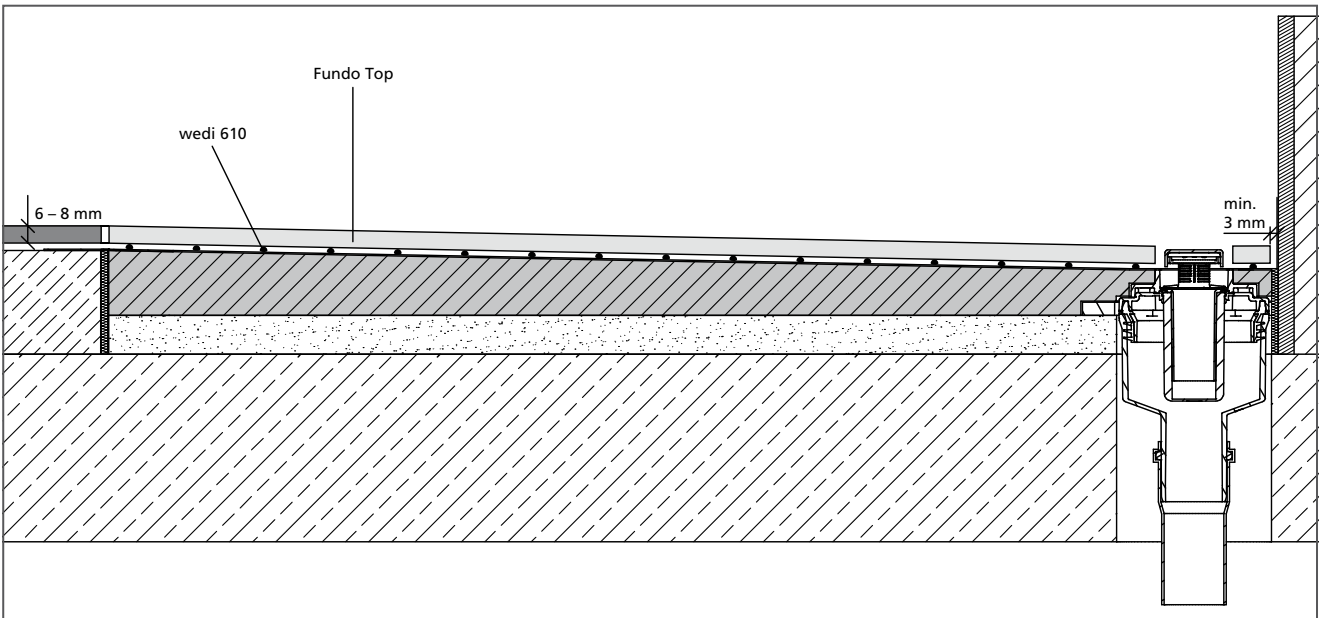
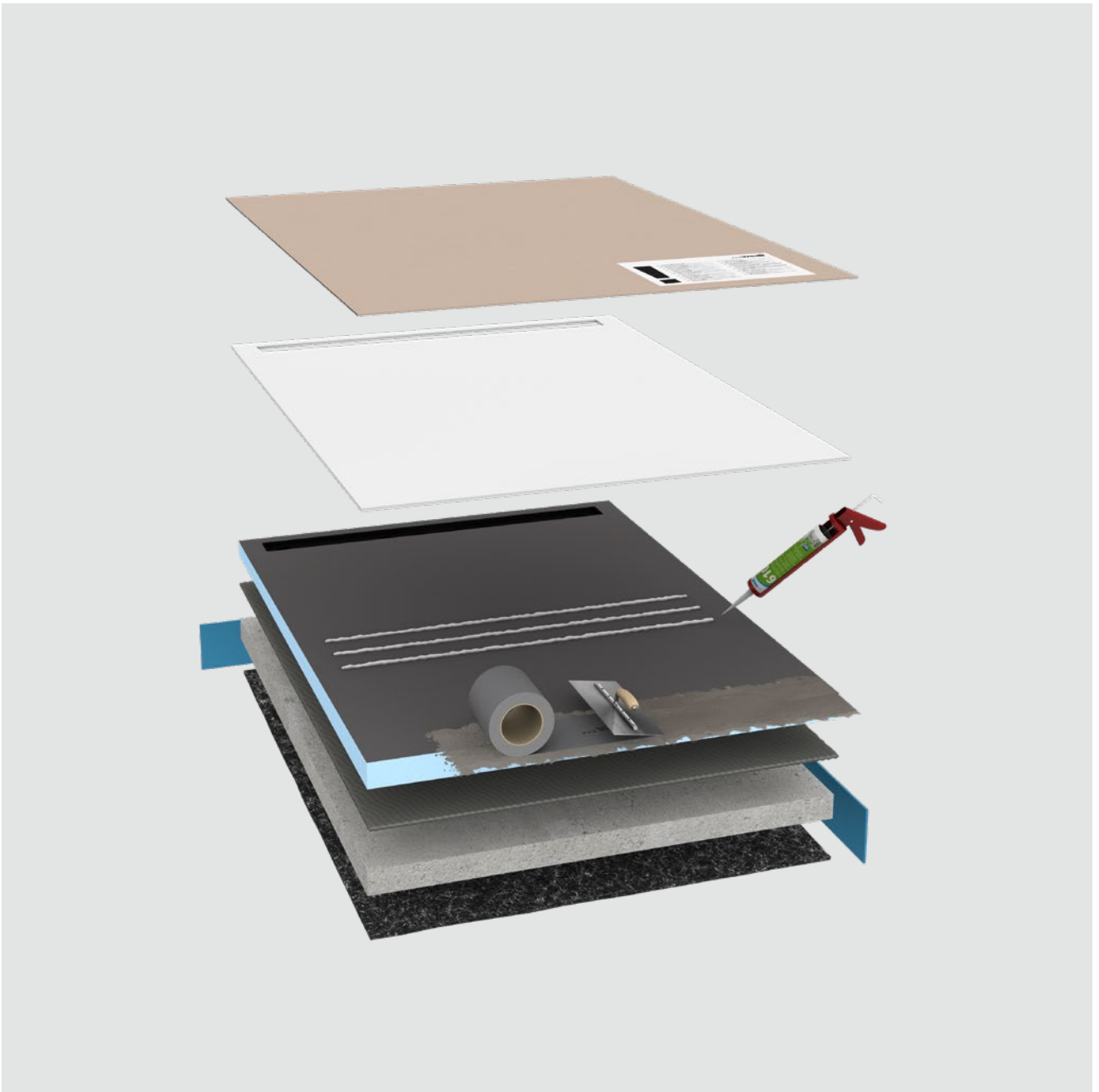

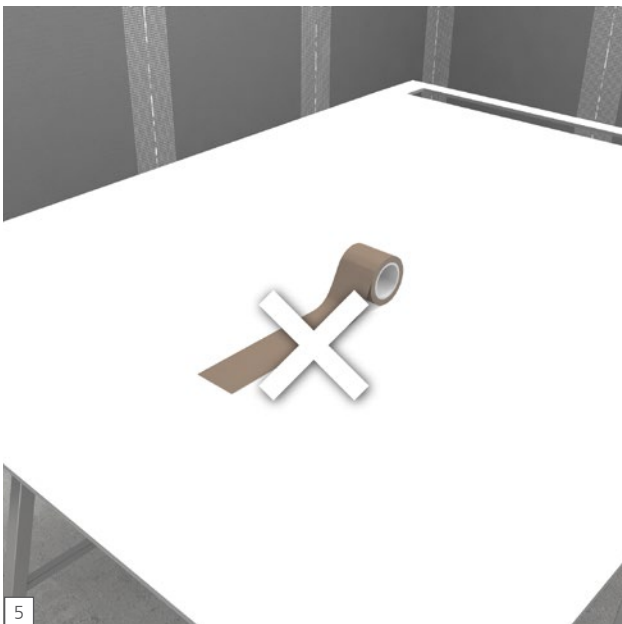
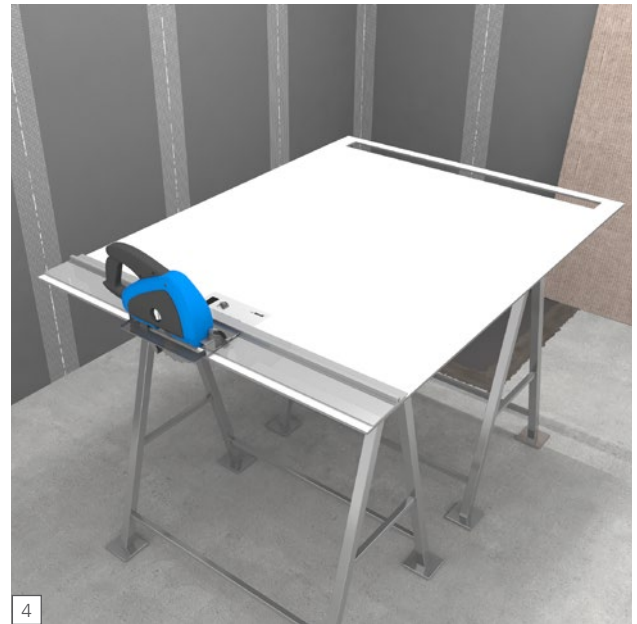

- |   |  |
|---|--|
| <input type="checkbox"/> DE Nicht bekleben!       | <input type="checkbox"/> SE Får ej klistras över!    |
| <input type="checkbox"/> EN No sticking!          | <input type="checkbox"/> FI Ei päälleliimausta!      |
| <input type="checkbox"/> FR Ne rien coller !      | <input type="checkbox"/> DK Må ikke overklæbes!      |
| <input type="checkbox"/> ES ¡No pegar!            | <input type="checkbox"/> RU Не облицовывать!         |
| <input type="checkbox"/> IT Non incollare!        | <input type="checkbox"/> GR Μη κολλάτε τίποτα επάνω! |
| <input type="checkbox"/> NL Niet beplakken!       | <input type="checkbox"/> HU Le-/ráragasztani tilos!  |
| <input type="checkbox"/> PL Nie oklejać!          | <input type="checkbox"/> CZ Nepolepovat!             |
| <input type="checkbox"/> PT Não efetuar colagens! | <input type="checkbox"/> SI Ne prelepiti!            |
| <input type="checkbox"/> NO Må ikke limes på!     | <input type="checkbox"/> HR Ne oblijepiti!           |



